



FITTING FUNCTION WITH STYLESM

Aluminum Fittings



- SAFETY COMPLIANT
- NO WELDING OR THREADING
- LIGHTWEIGHT AND VERSATILE
- HIGH CORROSION RESISTANCE
- REDUCED LABOR COSTS



See Page 12

Kee Lite® Aluminum Fittings

HANDRAILS • LIGHTING GRIDS • STORE FIXTURES • PLAYGROUNDS
SET DESIGN & PROPS • INDUSTRIAL • INTERIORS

Kee Lite Features

- Aesthetic Look and Design
- Lightweight
- Corrosion Resistant
- Large Set Screws Resist Thread Stripping
- Low Long Term Maintenance
- Available for Schedule 40 Pipe Sizes 1" - 2" *
- Recessed Set Screws for a Smooth Look
- Cost Effective Alternative to Welding

Kee Lite fittings are made from a high grade Aluminum Silicon Magnesium Alloy and provide you with a lightweight, corrosion resistant, and strong alternative for fabrication of pipe structures. Kee Lite fittings offer flexibility and can be used for a variety of applications from contemporary to industrial; your imagination is the only limitation.

Because Kee Lite fittings can be easily installed with a hex tool and pipe cutters, there is no need for welding, saving you both time and money. Kee Lite is securely locked into place using recessed set screws that provide a sleek and smooth look to your railing system or pipe structure.

More Kee Lite Applications

- Water Treatment Facilities
- Retail and Restaurant
- Parks and Recreation
- Institutional and Municipal Facilities

Kee Lite Safety Solutions

Kee Lite offers lightweight and versatile safety solutions. When Kee Lite fittings in Sizes 7, 8 and 9 are used to construct 42" high guardrailing, the railing will meet the requirements of the OSHA design standard of a single 200 lb. load applied at any location along the top rail when the correct specification of pipe is used, and the correct method of design is employed. The integrity of the structure to which the system is fixed, and the fixings used will also need to be checked to ensure they are capable of meeting the imposed load requirements. (Reference OSHA 29 CFR 1910.23)

Kee Lite fittings are available from Distributors throughout North America. To find the Distributor nearest to you, contact the Sales Staff at Kee Industrial Products at (800) 851-5181 in the USA, or (877) 505-5003 in Canada. On the internet, visit us at <http://www.keelite.com>, or email info@keelite.com.

* 1" - 2" Nominal Bore - See Pipe Reference Chart on page 12.



Photo Courtesy of Design Components, Inc.

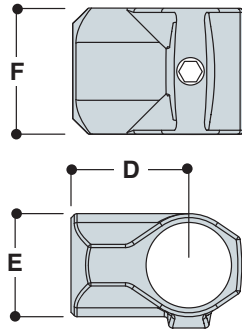
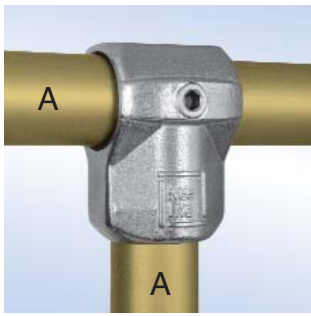

L10 Single Socket Tee

Designed to give a 90° butt joint between 2 pipes. Frequently used for the joint between end uprights and the middle rail where the railing site is straight and level. Also used for base ties on racking. This fitting cannot be used where the pipe through sleeve 'A' is required to be joined within the fitting.

TYPE	Pipe Ref.			Inches				
	A	B	C	D	E	F	G	lb.
L10-6	6			2.05	1.67	2.20		0.29
L10-7	7			2.56	2.09	2.52		0.44
L10-8	8			2.91	2.36	2.76		0.66
L10-9	9			3.54	2.91	3.23		1.06

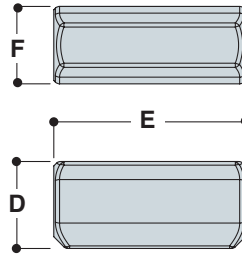
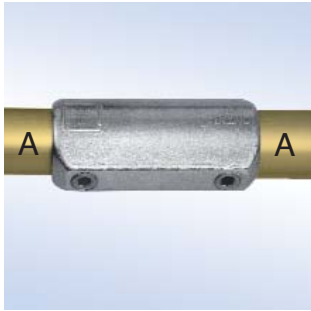

L14 Straight Coupling

Designed to give an inline joint between pipes of the same size. Frequently used to enable full pipe lengths to be used in railing applications.

Note: It is not advisable to join the upper and lower rails of a railing within the same bay.

TYPE	Pipe Ref.			Inches				
	A	B	C	D	E	F	G	lb.
L14-6	6			1.97	3.94	1.67		0.40
L14-7	7			2.32	5.12	2.09		0.73
L14-8	8			2.56	5.83	2.36		0.82

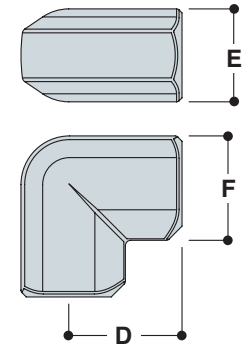
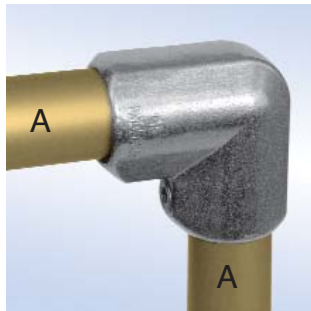

L15 90 Degree Elbow

A 90° elbow joint, most frequently used as an end joint for the top rail of safety railing on a level site.

TYPE	Pipe Ref.			Inches				
	A	B	C	D	E	F	G	lb.
L15-6	6			2.05	1.67	2.20		0.31
L15-7	7			2.56	2.09	2.32		0.62
L15-8	8			2.91	2.36	2.56		0.88
L15-9	9			3.54	2.91	3.07		1.46

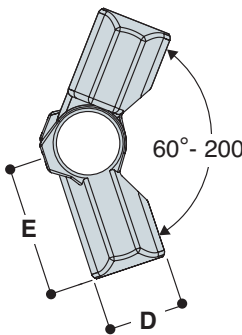
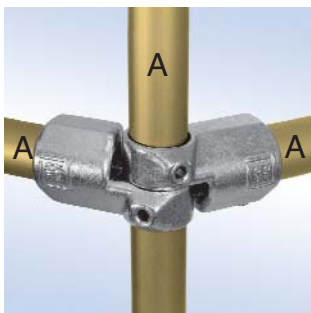

L19 Adjustable Side Outlet Tee

Used to form variable angle joints between 60 and 200 degrees.

Note: Type L19 fittings are bagged in pairs, and are weighed, priced, and sold as such.

TYPE	Pipe Ref.			Inches				
	A	B	C	D	E	F	G	lb.
L19-6	6			1.67	2.95			0.79
L19-7	7			2.09	3.54			1.28
L19-8	8			2.36	3.54			1.46

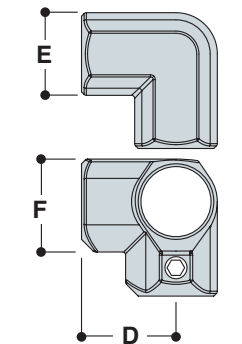
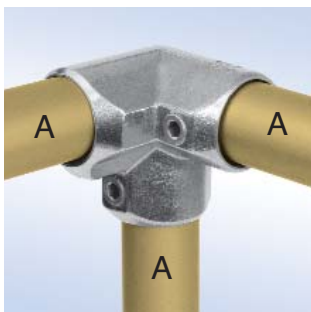

L20 Side Outlet Elbow

A 90 degree corner joint most frequently used for the top rail of safety railing. It can also be used for the corner joint of benches, work tables, and other rectangular structures.

TYPE	Pipe Ref.			Inches				
	A	B	C	D	E	F	G	lb.
L20-6	6			2.05	1.67	1.97		0.42
L20-7	7			2.56	2.09	2.32		0.77
L20-8	8			2.91	2.36	2.56		1.10

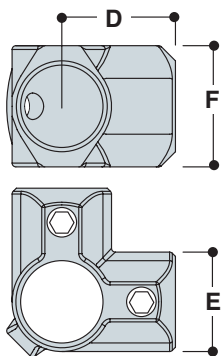
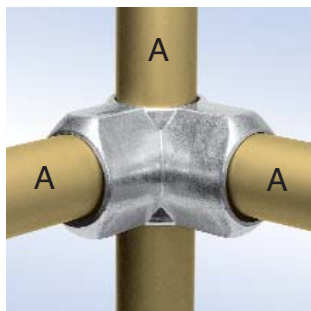

L21 90 Degree Side Outlet Tee

Most frequently paired with Type L20 to give a 90° corner joint for the middle rail of safety railing and other rectangular structures. The upright passes through the fitting.

TYPE	Pipe Ref.			Inches				
	A	B	C	D	E	F	G	lb.
L21-6	6			2.05	1.67	2.20		0.35
L21-7	7			2.56	2.09	2.52		0.66
L21-8	8			2.91	2.36	2.76		0.95

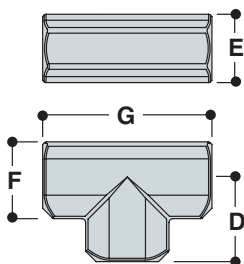
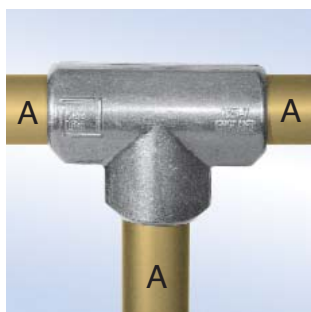

L25 Three Socket Tee

Commonly used as the 90° joint between the top rail and an intermediate upright on safety railing. As there are two socket set screws in the sleeve, this fitting can be used where a joint is required in the horizontal pipe. The Type L10 fitting can be used as an alternative when a joint in the pipe is not required.

TYPE	Pipe Ref.			Inches				
	A	B	C	D	E	F	G	lb.
L25-6	6			2.05	1.67	1.97	4.09	0.46
L25-7	7			2.56	2.09	2.32	5.12	0.77
L25-8	8			2.91	2.36	2.56	5.83	1.12
L25-9	9			3.54	2.91	3.07	7.09	1.81

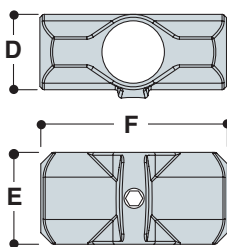
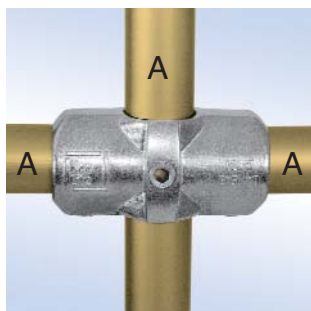

L26 Two Socket Cross

Usually paired with Type L25 to give a 90° joint between the middle rail and an intermediate upright on safety railing. The upright passes through the fitting.

TYPE	Pipe Ref.			Inches				
	A	B	C	D	E	F	G	lb.
L26-6	6			1.67	2.20	4.09		0.37
L26-7	7			2.09	2.52	5.12		0.62
L26-8	8			2.36	2.76	5.83		0.99
L26-9	9			2.91	3.23	7.09		1.46

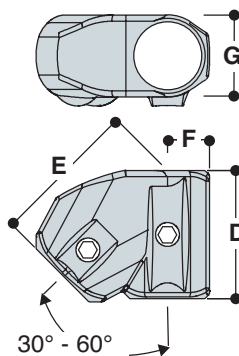
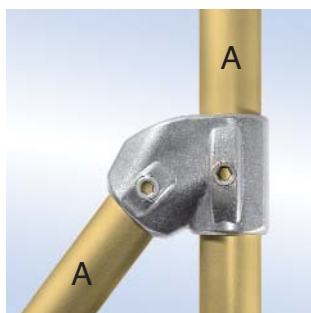

L29 30° to 60° Single Socket Tee

This adjustable fitting is most frequently used for struts and braces. It can be used at any selected angle between 30° and 60°. Suitable for connecting an angled staircase rail to a vertical upright.

TYPE	Pipe Ref.			Inches				
	A	B	C	D	E	F	G	lb.
L29-7	7			3.23	3.74	1.06	2.07	0.70
L29-8	8			3.66	4.25	1.18	2.32	0.90

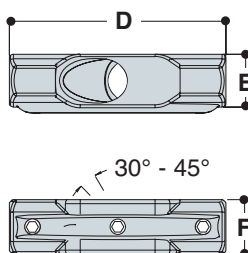
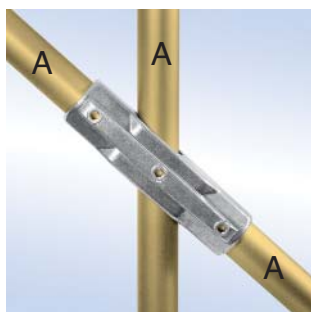

L30 30° to 45° Adjustable Cross

This adjustable fitting can be used for railing on staircases between the mid-rail and intermediate upright which is required to remain vertical. It can be used at any selected angle between 30° and 45°.

TYPE	Pipe Ref.			Inches				
	A	B	C	D	E	F	G	lb.
L30-7	7			8.46	2.07	2.13		1.15
L30-8	8			9.65	2.34	2.36		1.52

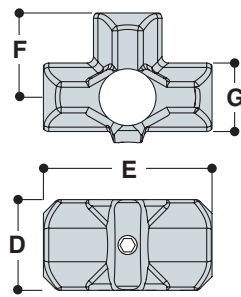
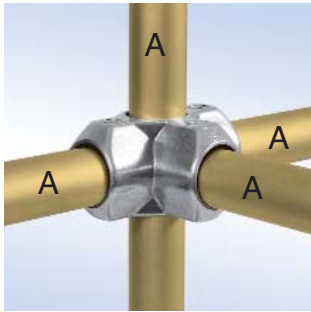

L35 Three Socket Cross

Most frequently used to tie uprights with horizontal pipe in three directions, all at 90 degrees to the upright. The upright passes through the fitting.

TYPE	Pipe Ref.			Inches				
	A	B	C	D	E	F	G	lb.
L35-6	6			2.20	4.09	2.05	1.67	0.68

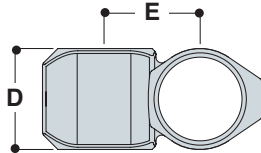
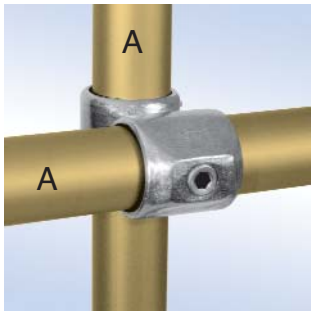

L45 Crossover

Designed to give a 90° offset crossover joint. Frequently used on safety railing utilizing a continuous horizontal rail, minimizing pipe cuts to reduce costs. Type L45 may also be used to allow intermediate levels on racks.

Warning: Pipe cannot be joined within this fitting.

TYPE	Pipe Ref.			Inches				
	A	B	C	D	E	F	G	lb.
L45-6	6			1.73	1.57			0.26
L45-7	7			2.13	1.97			0.68
L45-8	8			2.40	2.20			0.77

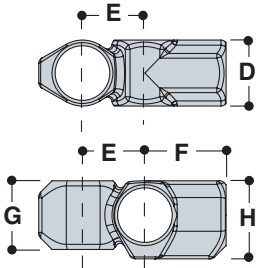
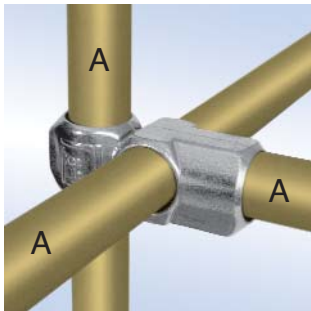

L46 Combination Socket Tee and Crossover

Used on racking to join horizontal carrying rails to the upright, leaving the socket to take a horizontal tie across the section. For shelved racking, it is usual to have the horizontal pipe outside the upright. On pallet racking, it is preferable to have the carrying rails inside the upright.

TYPE	Pipe Ref.			Inches					
	A	B	C	D	E	F	G	H	lb.
L46-6	6			1.67	1.57	2.05	1.73	1.97	0.42

Important Note: Swivel fittings are not designed to resist bending loads. A structure should not be designed entirely of swivel fittings as they will not provide sufficient stability for the structure.

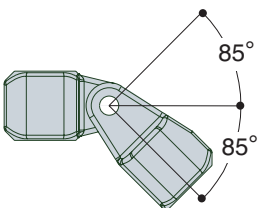
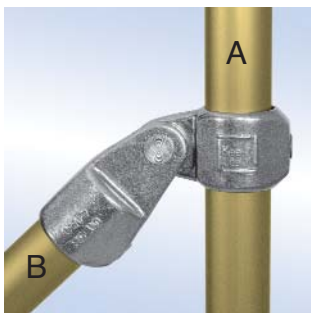

LC50 Single Swivel Socket

A complete combination swivel fitting, variable through 170 degrees.

TYPE	Pipe Ref.			Inches				
	A	B	C	D	E	F	G	lb.
LC50-66	6	6						0.68
LC50-77	7	7						0.90
LC50-88	8	8						1.10

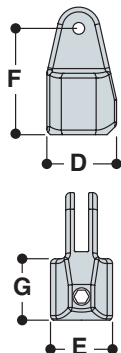

LF50 Female Single Swivel Socket Member

The female part of a swivel fitting combination.

∅ indicates diameter of rivet holes.

TYPE	Pipe Ref.			Inches					
	A	B	C	D	E	F	G	∅	lb.
LF50-6	6			1.97	1.67	2.95	2.09	0.38	0.37
LF50-7	7			2.32	2.09	3.54	2.32	0.38	0.55
LF50-8	8			2.56	2.36	3.54	2.64	0.38	0.64

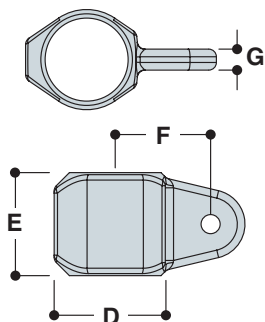
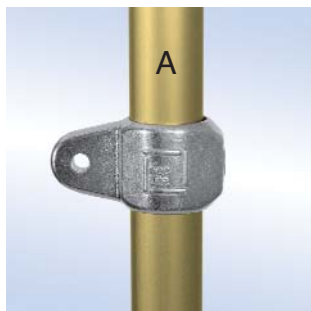

LM50 Male Single Swivel Socket Member

The male part of a swivel fitting combination. The fitting can also be used to attach flat panels to tubular structures.

Ø indicates diameter of rivet hole.

TYPE	Pipe Ref.			Inches						
	A	B	C	D	E	F	G	Ø	lb.	
LM50-6	6			1.97	1.73	1.85	0.43	0.38	0.26	
LM50-7	7			2.32	2.00	1.97	0.43	0.38	0.33	
LM50-8	8			2.56	2.36	2.17	0.43	0.38	0.44	

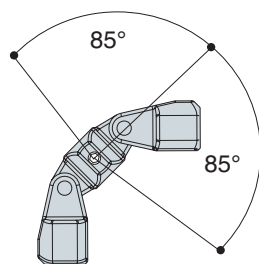
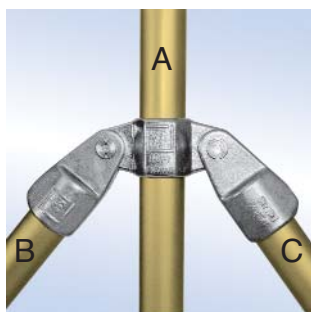

LC51 Double Swivel Socket

Complete combination fitting. Reducing combinations of Type LC51 are available in sizes 6, 7 and 8.

TYPE	Pipe Ref.			Inches						
	A	B	C	D	E	F	G	Ø	lb.	
LC51-666	6	6	6						1.26	
LC51-777	7	7	7						1.61	
LC51-888	8	8	8						1.88	

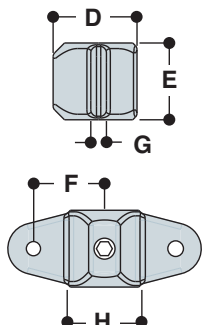
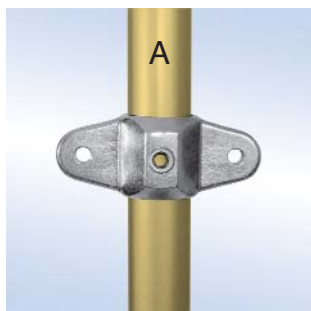

LM51 Male Double Swivel Socket Member

One half of a combination fitting. This fitting can also be used for attaching flat panels to tubular structures.

Ø indicates diameter of rivet hole.

TYPE	Pipe Ref.			Inches						
	A	B	C	D	E	F	G	H	Ø	lb.
LM51-6	6			1.97	1.73	1.85	0.43	1.67	0.38	0.35
LM51-7	7			2.32	2.00	1.97	0.43	2.09	0.38	0.51
LM51-8	8			2.56	2.36	2.17	0.43	2.36	0.38	0.60

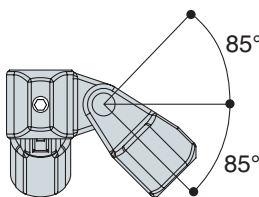
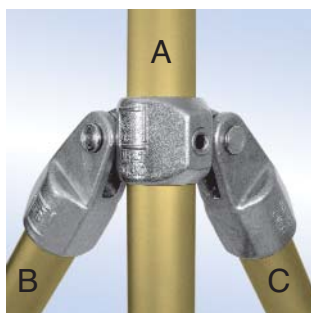

LC52 Corner Swivel Socket

Complete combination fitting. Reducing combinations of Type LC52 are available in sizes 6, 7 and 8.

TYPE	Pipe Ref.			Inches						
	A	B	C	D	E	F	G	Ø	lb.	
LC52-666	6	6	6						1.06	
LC52-777	7	7	7						1.48	
LC52-888	8	8	8						1.76	

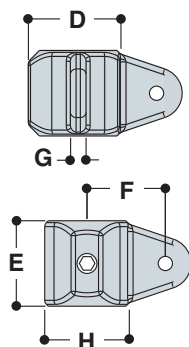
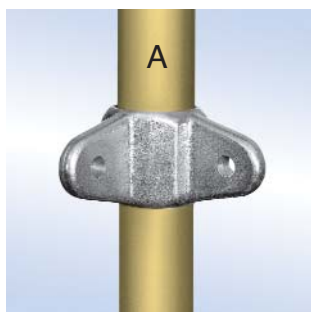

LM52 Male Corner Swivel Socket Member

One half of a combination fitting. This fitting can also be used for attaching flat panels to tubular structures.

Ø indicates diameter of rivet hole.

TYPE	Pipe Ref.			Inches						
	A	B	C	D	E	F	G	H	Ø	lb.
LM52-6	6			1.97	1.73	1.85	0.43	1.67	0.38	0.35
LM52-7	7			2.32	2.00	1.97	0.43	2.09	0.38	0.51
LM52-8	8			2.56	2.36	2.17	0.43	2.36	0.38	0.60

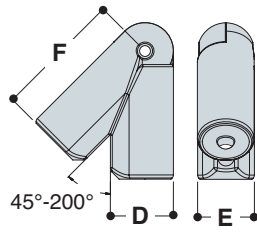
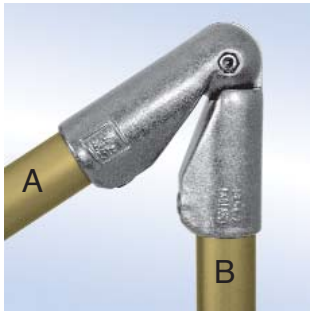

LB54 Adjustable Elbow

A swivel fitting designed as an inline variable angle connection, adjustable from 45 to 200 degrees. Nut and bolt included.

TYPE	Pipe Ref.			Inches				lb.
	A	B	C	D	E	F	G	
LB54-66	8	8		1.97	1.67	3.94		0.77
LB54-77	7	7		2.28	2.17	4.69		1.43
LB54-88	8	8		2.56	2.36	5.16		1.61

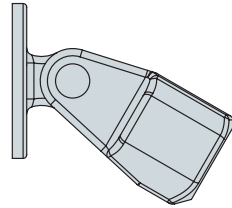
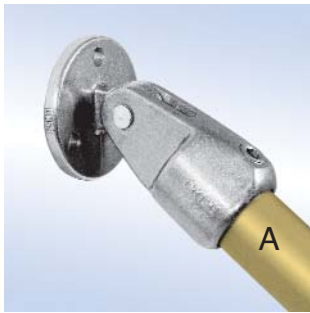

LC58 Swivel Flange

A swivel fitting for attachment of angled pipe to a flat surface.

Warning: This fitting is not recommended for use as a base flange to support guardrailing or balustrading.

Ø indicates diameter of fixing holes.

TYPE	Pipe Ref.			Inches						lb.	
	A	B	C	D	E	F	G	H	Ø		
LC58-6	6									0.45	0.74
LC58-7	7									0.45	0.93
LC58-8	8									0.45	1.23

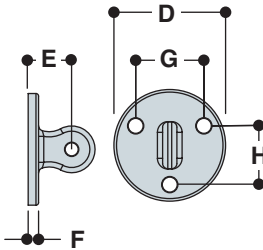

LM58 Male Wall Plate

The male part of a swivel fitting for attaching angled tubing to flat surfaces.

Ø indicates rivet and fixing hole diameters.

TYPE	Pipe Ref.			Inches					Rivet	Fixing	lb.
	A	B	C	D	E	F	G	H	Ø	Ø	
LM58				3.38	1.32	0.31	2.07	1.78	0.38	0.45	0.37

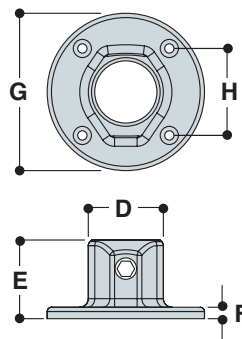
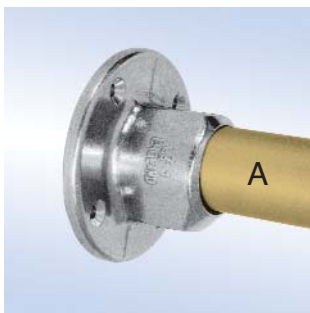

L61 Flange

This flange, with holes provided for countersunk head fixing screws only, is used in structures where the fixing required is positional only. Frequently used as a wall-fixing bracket. **Warning:** L61 is not recommended for use as a base flange to support guardrailing or balustrading. Use Type L152 if a base flange is needed. Ø indicates diameter of fixing holes.

TYPE	Pipe Ref.			Inches						lb.
	A	B	C	D	E	F	G	H	Ø	
L61-6	6			1.67	1.97	0.31	3.94	1.93	0.25	0.46
L61-7	7			2.09	2.17	0.31	4.33	2.40	0.25	0.64
L61-8	8			2.36	2.36	0.31	4.72	2.64	0.25	0.71

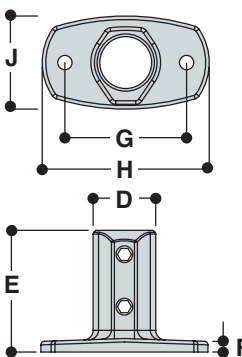
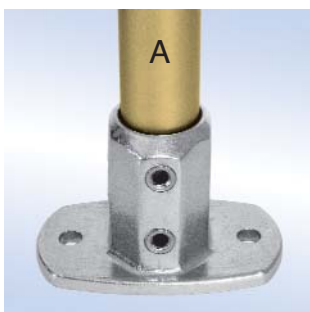

L62 Standard Railing Flange

Type L62 should always be used to fix down guardrailing and balustrades. Holes are of sufficient diameter to give a good fixing with either a mechanical or chemical anchor. Two set screws in the vertical socket give greater stability to the upright. It is recommended that the fixing holes in the flange be inline with the applied load. The pipe is able to pass through the base of the fitting. Ø indicates diameter of fixing holes.

TYPE	Pipe Ref.			Inches						lb.	
	A	B	C	D	E	F	G	H	J		Ø
L62-6	6			1.97	3.54	0.35	3.50	5.04	2.95	0.55	0.77
L62-7	7			2.18	3.54	0.35	4.02	5.51	3.23	0.55	0.94
L62-8	8			2.43	3.54	0.35	4.53	6.30	3.31	0.55	1.17

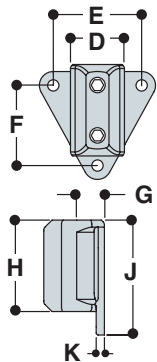
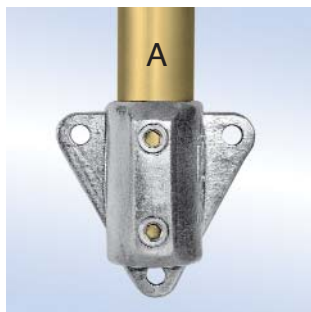

L68 Wall Flange

Side palm fixing for guardrailing and balustrading to walls, parapets, steps and ramps. The upright cannot drop through the socket.

Note: If the upright is required to pass through the fitting by machining out the base stop, the bottom fixing hole becomes unusable.

Ø indicates diameter of fixing holes.

TYPE	Pipe Ref.			Inches										lb.
	A	B	C	D	E	F	G	H	J	K	Ø			
L68-6	6			1.67	2.80	2.52	0.95	2.95	3.98	0.31	0.45	0.53		
L68-7	7			2.09	3.39	3.15	1.10	3.50	4.45	0.31	0.45	0.77		
L68-8	8			2.36	3.78	3.62	1.22	3.94	5.04	0.31	0.45	0.95		

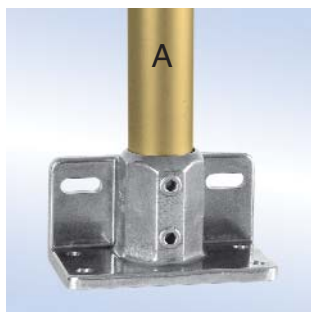

L69 Railing Flange With Toeboard Adapter

The L69 fitting has been designed for guardrailing and balustrading and allows attachment of a toeboard to the base. The base plate holes are of sufficient diameter to allow for attachment with either a mechanical or chemical anchor, the side plates have slotted holes to allow for a degree of sideways movement for ease of installation. A toeboard designed for use with the L69 fitting is available from Kee Industrial Products (see pg. 10).

Ø indicates diameter of fixing holes.

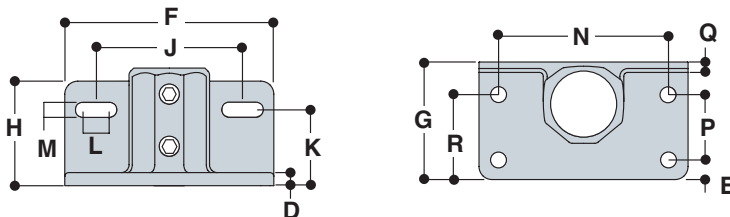

TYPE	Pipe Ref.			Inches															lb.
	A	B	C	D	E	F	G	H	J	K	L	M	N	P	Q	R	Ø		
L69-7	7			0.39	0.59	5.71	3.15	3.15	3.78	2.28	0.79	0.45	4.53	1.57	0.31	2.16	0.45	1.41	
L69-8	8			0.39	0.59	6.30	3.54	3.15	4.41	2.28	0.79	0.45	5.12	1.97	0.31	2.24	0.45	1.65	

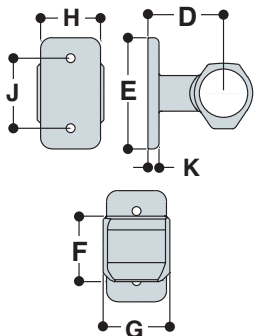
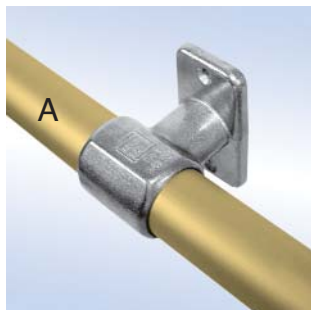

L70 Rail Support

This fitting, with holes provided for countersunk flat head screw fixings only, is designed to carry handrails along walls or to fix structures back to walls. The pipe passes through the fitting and cannot be joined within the fitting. Type 70 is also used to attach toeboards to the base of guardrail uprights.

Ø indicates diameter of fixing holes.

TYPE	Pipe Ref.			Inches										lb.
	A	B	C	D	E	F	G	H	J	K	Ø			
L70-6	6			2.36	3.62	1.97	1.97	1.77	2.68	0.39	0.31	0.44		
L70-7	7			2.68	4.13	2.32	2.36	2.13	3.19	0.39	0.31	0.75		
L70-8	8			2.95	4.53	2.56	2.60	2.36	3.58	0.39	0.31	0.99		

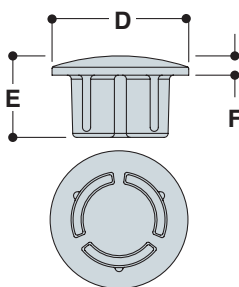

L84 Metal Plug

A metal drive-in plug. For proper insertion, a rubber mallet should be used. The metal plug is difficult to remove once installed.

TYPE	Pipe Ref.			Inches				lb.
	A	B	C	D	E	F	G	
L84-6	6			1.34	1.20	0.22		0.04
L84-7	7			1.69	1.22	0.24		0.11
L84-8	8			1.93	1.22	0.24		0.11

Comparison of styling for Sizes 6, 7, 8 and 9 for Kee Lite Type L10. Several Kee Lite fitting styles come in a full range of sizes to fit Schedule 40 pipe sizes 1 inch through 2 inches.

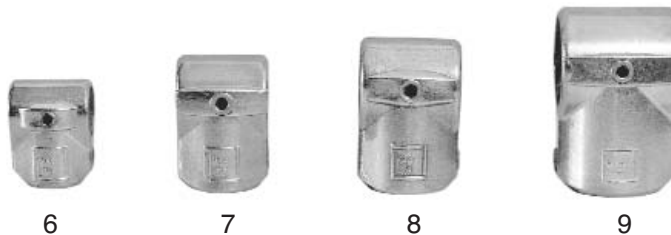

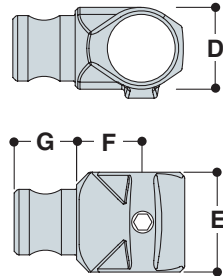
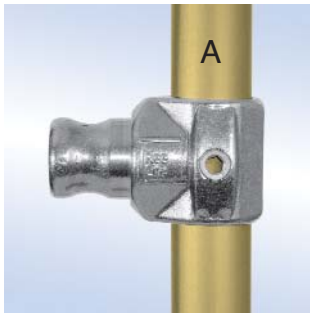

L114 Swivel Tee

An internal swivel fitting designed to accommodate varying angles on handrailing to staircases, ramps, or bracing. Used in conjunction with Types L10, L15, L25, or L45, it eliminates the need for specialty drilled angle fittings.

TYPE	Pipe Ref.			Inches							
	A	B	C	D	E	F	G	H	Ø	lb.	
L114-6	6			1.97	2.20	1.77	1.26				0.40
L114-7	7			2.09	2.52	1.69	1.57				0.64
L114-8	8			2.36	2.76	1.81	1.57				0.78

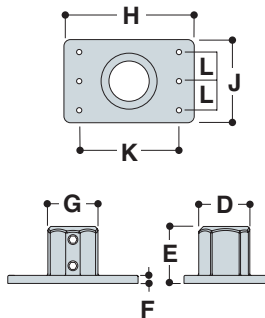

L148 Heavy Duty Rectangular Flange

Type L148 is a structural base fixing used to fix down guardrailing and balustrading. This fitting available with either 2 or 4 fixing holes which are sufficient diameter to give a good fixing with either a mechanical or chemical anchor. The two socket set screws give greater stability to the upright. It is recommended that fixing holes be inline with the applied load.

Ø indicates diameter of fixing holes.

TYPE	Pipe Ref.			Inches									
	A	B	C	D	E	F	G	H	J	K	L	Ø	lb.
L148-9/2	9			3.07	3.43	0.47	3.03	7.80	5.12	6.00	1.75	0.81	2.49
L148-9/4	9			3.07	3.43	0.47	3.03	7.80	5.12	6.00	1.75	0.55	2.49

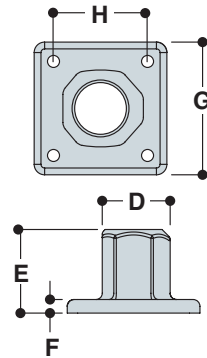
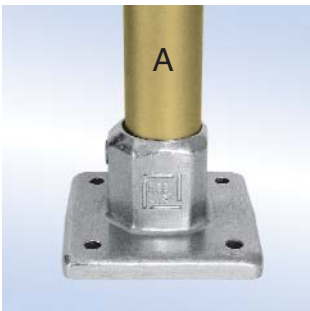

L150 Heavy Duty 4 Hole Square Flange

A heavy duty, four point fixing base flange. Ideal when a structural fixing is required.

Ø indicates diameter of fixing holes.

TYPE	Pipe Ref.			Inches						
	A	B	C	D	E	F	G	H	Ø	lb.
L150-8	8			2.56	3.00	0.51	5.00	3.50	0.45	1.61

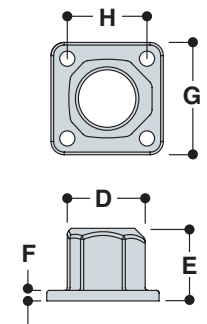

L152 4 Hole Square Flange

A four point fixing base or wall flange.

Ø indicates diameter of fixing holes.

TYPE	Pipe Ref.			Inches						
	A	B	C	D	E	F	G	H	Ø	lb.
L152-6	6			1.97	1.81	0.25	2.99	2.06	0.31	0.35
L152-7	7			2.32	2.17	0.31	3.35	2.38	0.45	0.59
L152-8	8			2.56	2.56	0.31	3.62	2.63	0.45	0.68

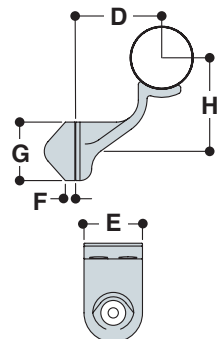
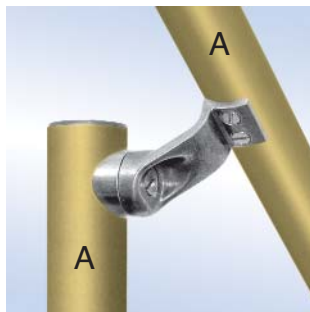

L160 Smooth Handrail Fitting

Designed to provide attachment for a smooth handrail which complies with the Americans with Disabilities Act of 1990. The fitting swivels during installation, allowing the handrail to be placed at any angle. The fitting is supplied as a kit including fasteners. Ref 'A' refers to the diameter of the post.

TYPE	Pipe Ref.			Inches						
	A	B	C	D	E	F	G	H	lb.	
L160-7	7			2.32	1.57	0.39	1.57	2.52	0.24	
L160-8	8			2.32	1.57	0.31	1.57	2.64	0.22	

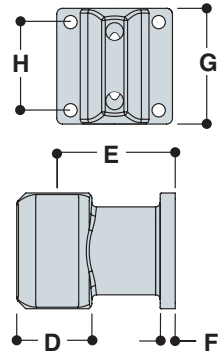

L164 Offset Wall Flange

This fitting is designed for side palm fixing of uprights to steel channels, walls, parapets, steps, and ramps. The upright cannot drop through the socket.

Ø indicates diameter of fixing holes.

TYPE	Pipe Ref.			Inches						
	A	B	C	D	E	F	G	H	Ø	lb.
L164-8	8			2.56	4.00	0.50	4.00	3.00	0.45	1.87

Kee Lite Accessories



59 Spigot Flange

A spigot flange which fits inside the pipe and is not secured by a set screw. Type 59 can only be used with pipe wall thickness of 1/8" and in light, self-supporting structures. Available in Kee Lite Sizes 6 through 9. Manufactured in aluminum. *No fixing holes are provided in this fitting.*



77 Plastic Plug

A grey plastic plug to fit open ended pipes. Also see Kee Lite Type L84. This plug can be used with Schedule 40 or 80 pipe only. Available in Sizes 6 through 9.



Heavy Duty Ratchet Set
Part Type 98



For highly corrosive environments, stainless steel set screws are available at a small additional charge.

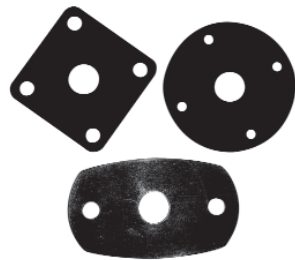

Neoprene Gaskets

Gaskets are available to prevent the corrosion associated with lime in concrete. The gaskets have more resistance than natural rubber to sunlight, ozone, and oxidation. Neoprene is heat resistant and does not soften as natural rubber does under severe exposure. Gasket part numbers correspond to Kee Lite wall and base fittings numbers as follows:

LG58	LG62-8	LG69-8	LG150-8
LG61-7	LG68-7	LG70-6	LG152-7
LG61-8	LG68-8	LG70-7	LG152-8
LG62-7	LG69-7	LG70-8	LG164-8



L69 Toeboard Option

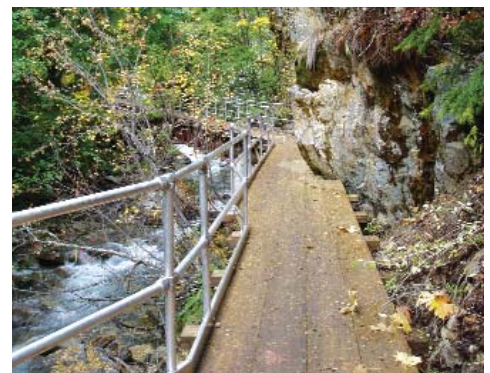

Used with fitting Type L69 Railing Flange, this option meets OSHA requirements for toeboards. The toeboard is 4" high and is made of aluminum. A channel in the toeboard accepts the bolt head of the mounting hardware allowing ease in placement. Toeboard is sold by the linear foot. Mounting hardware available separately.

Kee Lite Railing Fittings Assembly and Installation Guide

STRAIGHT AND LEVEL GUARDRAILING

(Using Types L10, L15, L20, L21, L25 & L26)

Where:

L= distance between centers of uprights

I = length of horizontal pipe

H= distance from ground to center line of top rail

h= length of upright pipe

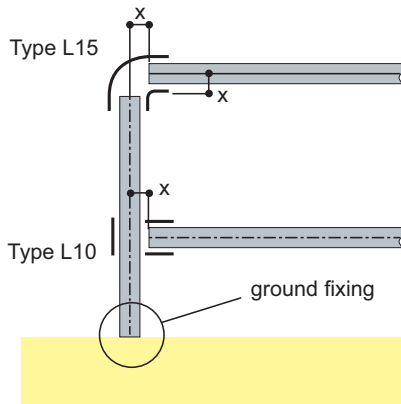
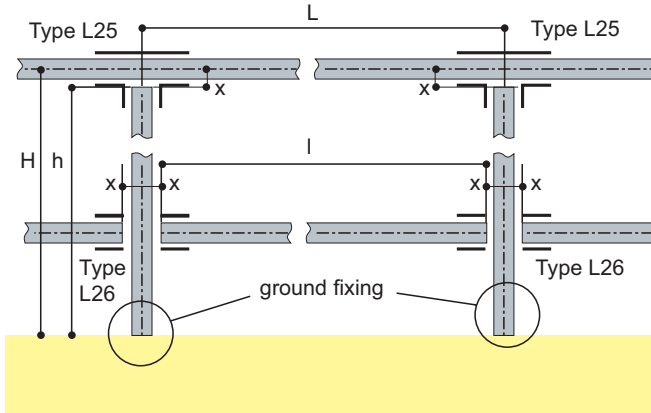

Table 1 gives details of dimension 'x' in the formula

$I = L - 2x$ for calculating rail lengths and uprights

$h = H - x \pm$ (ground fixing).

Table 1

Kee Lite Fitting Size	x (in)
6	5/8
7	7/8
8	1
9	1 1/8

BASE & WALL FIXINGS

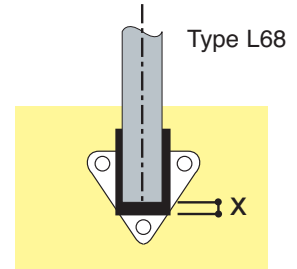
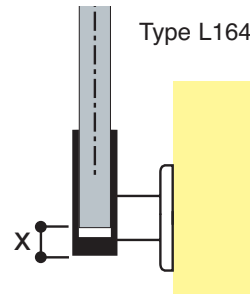
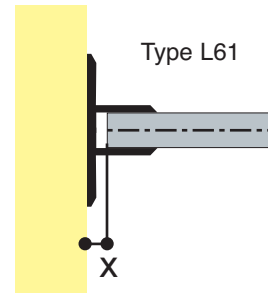
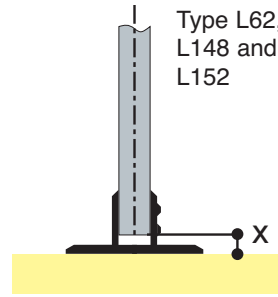

Table 2 gives details of the ground fixing dimension 'x', to be subtracted from the height 'H' to give the length of the upright 'h'.

Table 2

Flange Type	x (in)
L61	1/4
L62	1/4
L148	1/4
L152	1/4

Table 3 gives the dimension 'x' to be subtracted from the length of the upright for fitting Types L68 and L164.

Table 3

Kee Lite Fitting Size	x (in)
6	1/4
7	1/4
8	1/4
9	1/4



Kee Lite® Technical Information

- Kee Lite Fittings are made from high grade Aluminum Silicon Magnesium Alloy
- Recommended set screw torque for Kee Lite Size 6 is 20 lbs./ft.
- Recommended set screw torque for Kee Lite Size 7, 8, 9 is 29 lbs./ft.
- Minimum slip load capacity for Sizes 7, 8, and 9 on aluminum Schedule 40 pipe: 1,700 lbs (Safety Factor = 2)
- Minimum slip load capacity for Sizes 7, 8, and 9 on steel Schedule 40 pipe: 2,000 lbs (Safety Factor = 2)
- Set screws are designed to resist thread stripping
- Minimum Material UTS: 33,000 PSI
- A range of Kee Lite Fittings have undergone independent testing by TÜV

The current TÜV Certificate with a listing of tested components can be found on the www.keelite.com website

Registered design rights relating to one or more of the fittings in the Kee Lite range exist in various countries.

ADA Compliant Handrail

The Americans With Disabilities Act of 1990 requires that public buildings and facilities are accessible. Hotels, theaters, shopping complexes, retail stores, museums, libraries, parks, restaurants, day care centers, private schools, and similar places of public accommodation may not discriminate on the basis of disability (Reference 28 CFR 36.201). New construction must be accessible, and physical barriers in existing places of public accommodation must be removed if readily achievable. Kee Lite Type L160 is complaint with ADAAG (ADA Accessibility Guidelines) for handrails and ramps.



Kee Lite Pipe Reference Chart

Kee Lite Pipe Ref.	Nom. Bore* inches	Pipe Dia. O.D. inches	Fitting I.D. inches	Tube Dia. O.D inches
6	1	1.32	1.38	1 5/16
7	1 1/4	1.66	1.72	1 5/8
8	1 1/2	1.90	1.94	1 7/8
9	2	2.38	2.41	2 3/8

*Nominal Bore is an arbitrary dimension because the bore varies with the wall thickness of the pipe. Pipe sizes are shown in the table and in the drawings below.

Pipe For Your Structure

Structures built using Kee Lite Fittings will require either steel or aluminum pipe. We suggest using Schedule 40 Anodized Aluminum Pipe, Alloy 6105 - T5/6 which we have in stock. Pipe is available for fittings sizes 6, 7, 8 and 9 in either 24 foot or 12 foot long sections. We can even cut pipe to your exact requirements.

Kee Lite Aluminum Fittings are designed to suit Schedule 40 (aluminum and steel) pipe sizes 1" - 2".

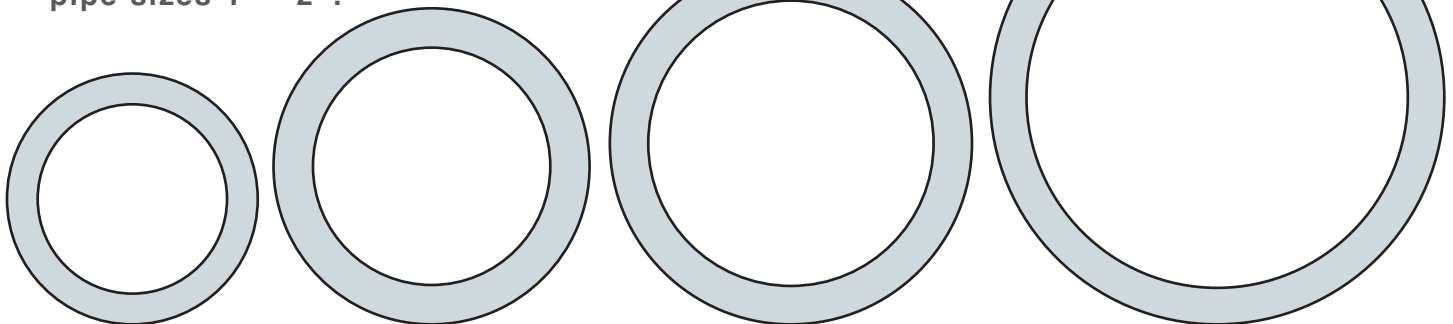

Size 6

Size 7

Size 8

Size 9

USA

Kee Industrial Products, Inc.
 100 Stradtman Street
 Buffalo, NY 14206
 Telephone: (716) 896-4949
 Fax: (716) 896-5696
 Toll Free (800) 851-5181

Canada

Kee Industrial Products, Ltd.
 219 Connie Crescent, Unit 9
 Concord, Ontario L4K 1L4
 Telephone: (905) 669-1494
 Fax: (905) 669-4347
 Toll Free (877) 505-5003

Internet

Website: www.keelite.com
 Email: info@keelite.com



Kee Lite is a Registered Trademark of Kee Klamp Limited. No part of this publication may be reproduced in any form without prior written permission from Kee Industrial Products. Copyright ©2007 Kee Industrial Products, Inc. All Rights Reserved.